



GEV-100-12

Battery for Electric-vehicle

GEV Series VRLA Gel Battery is specially designed for electric vehicles, i.e. electric automobiles, electric road vehicles, golf cart, low speed electric cart, etc. and other devices require DC power source. The GEV Series adopts international leading technologies to ensure the batteries with features of long cycle life, large current discharge capability, high reliability and safety, and environmental-friendly.

▶ Features

- > **Extra Long Life:** GEV Series are designed with high quality grid alloy enables the grid with features of anti-corrosion, low gas emission and excellent deep cycle performance, as well as high density and special deep cycle lead paste prescription is adopted to ensure extra long cycle life. The cycle life may reach 600+ cycles at 80% DOD.
- > **High Capacity and High Energy Density:** GEV Series are designed with adequate active material and higher electrolyte density to increase the battery's capacity within certain dimension and weight, so as to keep the battery with high energy density to be compatible with most of the electric vehicle without providing extra space to install batteries.
- > **High Reliability and Safety:** High strength ABS battery container and lid, perfect safety valve design, and high strength & excellent large current electroconductivity copper terminal design are adopted to ensure the GEV Series with high reliability and safety at extreme condition.
- > **High Environmental Adaptability:** GEV Series adopts special fumed silica Gel in electrolyte and special Gel type separator to prevent electrolyte stratification. This can significantly improve the battery's service life and environmental adaptability.
- > **Non-Cadmium Design, Environment-friendly:** GEV Battery has adopted internationally leading technology - container formation non-cadmium production technology, which is in the leading position in the industry. It helps to save energy 28.5%, save water 90%, and non-discharge of waste water.

▶ Charge Curve

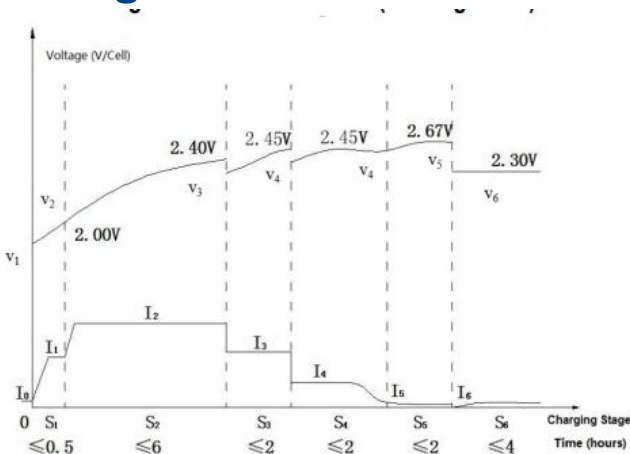

▶ Dimention

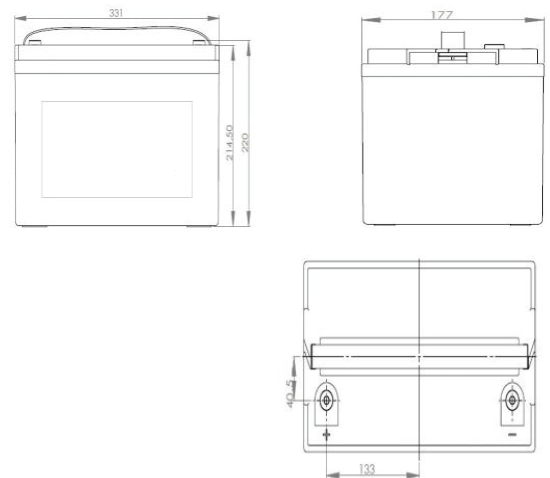

- All mentioned values are average values (Tolerance ±5%).
- Specifications could be subject to change without any prior notice.
- ECO//SUN is not responsible for any print errors.
- This version replaces all previous ones

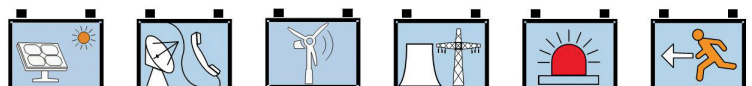

Discharge Curves at Different Discharge Rate (25°)

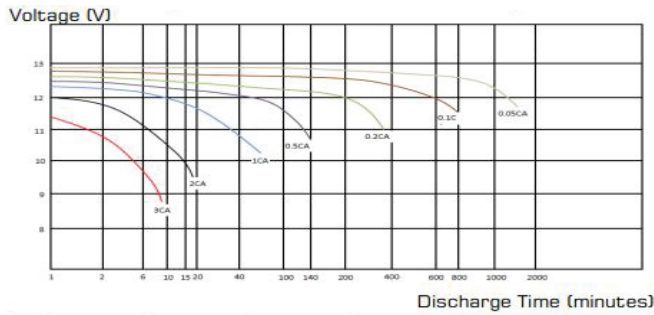

Discharge Characteristics at 3hr Rate

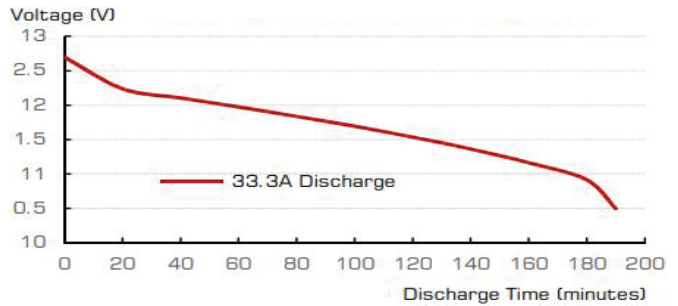

Effect of Temperature on Capacity

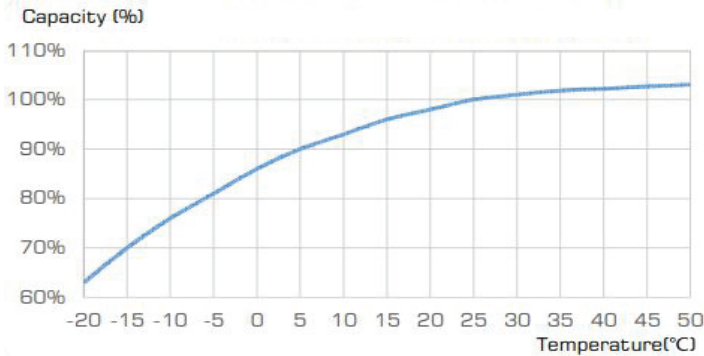

Capacity Retention Characteristics

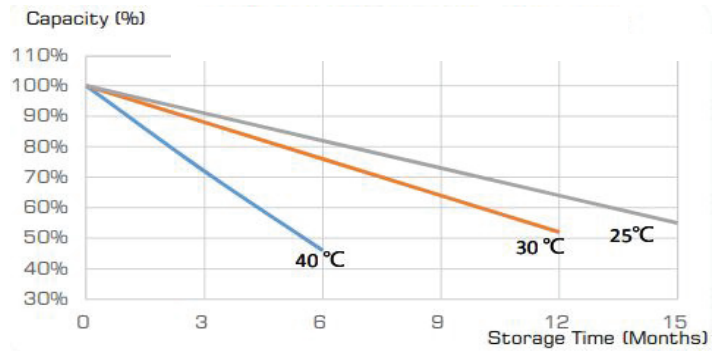

Cycle Life vs. DOD

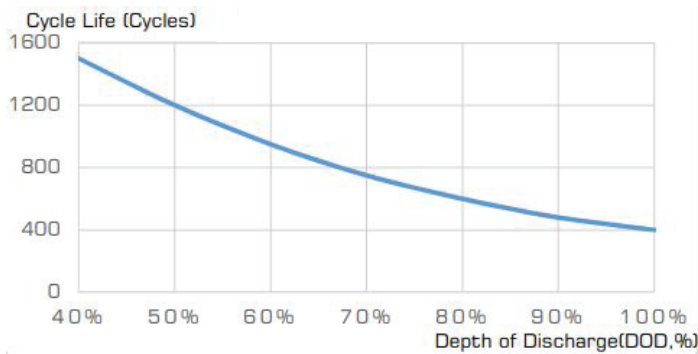

Number of Cycles vs. Capacity

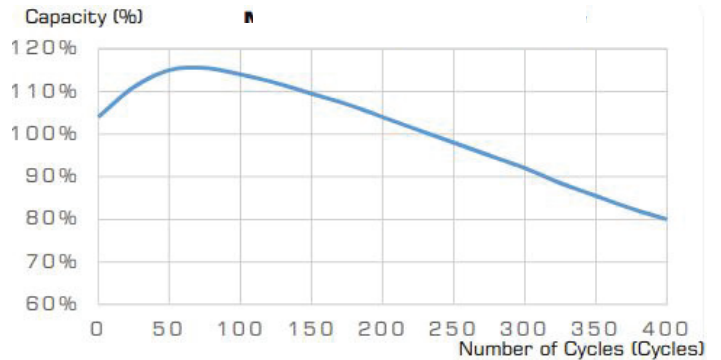

Discharge Amps (25°C)

Type	Volts (V)	C2 Hr	C3 Hr	C5 Hr	C10 Hr	Weight (Kg)	Dimensions in (mm)		
							Lenght	Width	Height
GEV-100-12	12	88	100	110	125	36	331	177	220

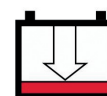
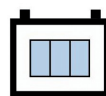

- All mentioned values are average values (Tolerance $\pm 5\%$).
- Specifications could be subject to change without any prior notice.
- ECO//SUN is not responsible for any print errors.
- This version replaces all previous ones

V18.0515